



# CONSTRUCTION OF INVERTER POWERED LAWN MOWER

**Olawale, Olamide\***

Department of Chemical Engineering, Landmark University, Omu-Aran, Kwara State,  
Nigeria.

**Adekunle, Adefemi Adeyemi**

Department of Mechatronics, Federal University Oye-Ekiti, Ekiti State, Nigeria.

**Osueke, Christian**

Department of Mechanical Engineering, Landmark University, Omu-Aran, Kwara State,  
Nigeria.

**Olayanju, Adeniyi**

Department of Agricultural and Biosystems Engineering, Landmark University, Omu-  
Aran, Kwara State, Nigeria.

**Akinyemi, Banjo**

Department of Agricultural and Biosystems Engineering, Landmark University, Omu-  
Aran, Kwara State, Nigeria.

## ABSTRACT

*The need for the maintenance of lawns through cutting and trimming cannot be overlooked in sporting fields, residential houses, hotel, hospital and others. Furthermore; some lawns are specially bred for the sake of aesthetic. However, in some places like hospitals, special health care and rehabilitation centers, the natural beauty of the environment is believed to contribute to a great deal in aiding the recovery and healing the mentally and physically challenged patients. This contributory effect on the lawn has made lawn care to be involved with a great admiration. An inverter powered lawnmower was designed and constructed using the locally available materials such as a 2KVA inverter, prime mover (electric motor) of a rating of 370W, a 60Amp hour battery and a 12 Volt battery. It is of advantage over the existing ones because it uses no fuel consumption, it emits no smoke which causes air pollution, and it has no internal combustion engine to drive the motor of the machine. This lawn mower was designed to mow for a period of two (2) hours and the discharged battery can be recharged with the aid of the inverter when connected to an A.C supply. This study showed that this*

Olawale, Olamide, Adekunle, Adefemi Adeyemi, Osueke, Christian, Olayanju, Adeniyi and Akinyemi, Banjo

*type of machine is most suitable in Nigeria because no fuel is needed to power this machine. The unit is simple, light and easy to maneuver.*

**Key words:** Battery, Frames, Inverter, Motor, Rotary blade, Wheels.

**Cite this Article:** Olawale, Olamide, Adekunle, Adefemi Adeyemi, Osueke, Christian, Olayanju, Adeniyi and Akinyemi, Banjo, Construction of Inverter Powered Lawn Mower International Journal of Civil Engineering and Technology, 10(01), 2019, pp. 1109-1121

<http://www.iaeme.com/IJCIET/issues.asp?JType=IJCIET&VType=10&IType=01>

## 1. INTRODUCTION

A lawn, unlike a piece of land used for cultivation of crops and other farming or agricultural processes, is a piece of land upon which special types of grasses are raised and bred for some special and desirable purpose. This special type of piece of land is so desirable by man that is found almost everywhere man exist, e.g, schools, hotels, offices, homes, parks etc. The essence of breeding of grass is different from one environment to the other. Lawn existence can be traced as far back as the inception of vegetation on the earth, and maintenance has been attached to it ever since. Due to the above versatile use of lawns, good maintenance processes have been adopted through the ages by the use of hand equipment such as cutlasses and hoes. This process, as time revealed was seen to be highly demanding in terms of energy, labour, time and resources. It is, however tedious and time consuming in cutting the lawn with cutlass, the hoe and the likes [1]. Good maintenance of the lawn makes the area to be safe by not harboring dangerous crawling animals like snake. A modern football field is the one of which the maintenance must be done regularly and perfectly in uniformity. In developed countries like USA where lawn care is a more or less culture, existing grasses are less compared to those found in tropical rain forest like Nigeria, hence the ruggedness and rigidity of a lawnmower suitable for use in this area is expected to be stronger compared to that of other areas.

Moreover, in Nigeria, which is regarded as a developing country, there is a need for cheap, affordable, easy to operate and durable lawn mower, having cheap, simple parts which are capable of meeting the need of our present environment, Nigeria. In achieving this, there is a need for the design, analysis based on our environmental factors, availability of materials and economy [2].

The research work will look into the:

- designing of an inverter powered lawn mower
- construction of the lawnmower which is about a safe operation
- testing the effectiveness and functionality of the lawnmower.

Before the invention of mowing machine in 1830, mowing was managed very differently (Peter, 2003).

Wealthy people's lawn was sometimes maintained by the labour intensive methods of scything and shearing in most cases. However, they are pastureland which was maintained through the grazing of sheep or other livestock. An area of grass grazed regularly by rabbits, horses or sheep over a long period often from a very low, tight cut similar to modern lawn. This was the original meaning of the word "lawn" and the term can still be found in place of some forest areas where extensive grazing is still practiced where these semi natural lawns exist. For example, in the new forest, England, such grazed areas are common and are lawns e.g Balmer lawn [4].

## 2. EXPERIMENTAL DESIGN

Basically, there are two different categories of lawn mower; the reel lawn mower and the rotary blade lawnmower. Research had shown that as manufactures continue to work towards designing a better mower, greater emphases were being placed on Ergonomic design. With the labour shortage in the landscaping industry, the populace needs to work longer hours and they want riding equipment that is easier to operate. That means features like higher-back seats and lower noise level, control properly place, things colour-coded, easy on-and-off switches [5].

It was reported that companies are continuing to pursue alternative fuel sources for reduce air and noise pollution. Concerning about the effect that, emissions from lawn mowers and other lawn and garden equipment are affecting the atmosphere, the U.S Environmental Protection Agency is toughening emission standard for small engines such as those used on lawn mowers. “Significant changes in the diesel engines” [6]. Batteries and fuel cells will progress to the point that they will be able to provide more power to trim turf without waking up the neighborhood from sleep, [3] referred to absolutely noiseless machines. However; in the same line, manufacturers are trying to make lawn mowers simple to operate even for someone with no experience or mechanical background. Labour shortage means it is not always possible to have someone with knowledge of mechanics, or even speak English; we are working to make the controls easy to operate and learn, so that a worker is ready to know immediately [4].

### 2.1. Current Innovation

The current design of this research work is a rotary type of mower, which is “single-powered”. Single-powered implies that the input power source is by an inverter which helps to power the mower with the aid of battery. It is an electronic device which is small with no engine emission unlike the internal combustion engine type. This inverter powered lawn mower requires human power in pushing or moving the machine while the moving process is in place. The technology combined early design and the present requirement in the mowing world. An inverter is an electrical device which converts the electrical energy stored in a battery from a direct current to an alternating current which is to be used by loads or appliances. The electrical energy that is used by the inverter is through the discharging of the battery and needs to be replaced by recharging with the aid of solar panel or an alternator.

A solar powered lawn mower that was designed and constructed in the past cannot be used for a longer period (1 – 2 hours) depending on the rating of the solar panel and ampere hour rating of the battery. This is simply because the solar panel receives energy from the sun is converted to the energy required to charge the battery and this can only be achieved during the daylight. i.e. the lawnmower cannot be used when there is no sunlight. This is the major difficulty that was encountered in using the solar powers inverter lawnmower.

Nevertheless; in overcoming this shortcoming of the solar powered inverter lawnmower, an alternator can be introduced to replace the solar panels, and generates a continuous energy which is required to charge the battery. This will enable the lawn mower to be used for more hours compared to the solar powered one. An inverter powered lawn mower required less maintenance compared to a lawnmower which is powered by an internal combustion engine and this will conserve the rates of generating power with the use of fuel. This design of a lawnmower can be more useful in an environment where there is scarcity of fuel.

### 2.2. TODAY’S TECHNOLOGY

Today’s new technology is bringing up advanced mower versions. Low emission gasoline engine with catalytic converters are being manufactured to help reduce air pollution. Improved

muffling devices are also being installed to reduce the noise pollution. Battery powered mowers are also becoming practical, although, slightly smaller unit with an average cutting swath of only 17"-19". These new mowers will quietly cut lawns without the common cloud of blue smoke hanging in the air, for about an hour per charge. Manufacturers are continually studying technological development to see how they can build a better mower [8].

### **3. MATERIALS AND METHOD**

A rotary blade type lawn mower was designed and powered by an inverter of an adequate rating. This inverter powered a motor that generated a rotary motion and torque, which was transmitted through the main shaft of the motor directly to the rotary blade which was attached to the keyed wheel coupled to the end of the main shaft.

The materials used for the fabrication of lawn mower were mainly sourced from locally. The aim of producing the machine at the lowest possible cost, increasing its economic efficiency and making its availability to the end users was made possible.

The factors considered in the selection of materials are the following:

- i. Availability of the materials
- ii. Mechanical property (Machinability, toughness, strength, durability)
- iii. Cost.

#### **3.1. Materials**

##### ***3.1.1. Inverter***

This is an electrical device which converts a direct current (d.c) which is supplied from a battery with an alternating current and also step-up the voltage that is required for the running of the motor (220v). It has a switch to put on and put off the machine.

##### ***3.1.2. Battery***

This is an electrical device which generates an electrical energy in the form of direct current (d.c) that is by electrical appliances. This is the source of electrical energy for the inverter that powers the lawn mower.

##### ***3.1.3. Prime mover (motor)***

This is an electro-mechanical device that produces the torque and rotary motion which is required to spin the rotary blade assembly for the mowing process. It is a high-speed motor with a power rating and speed of 0.37kw (0.5hp) and 2850 rpm respectively. The engine shaft is 15mm in diameter.

##### ***3.1.4. Wheels***

These support the loads on the frame base of the machine and also aid the movement of the machine while mowing. The wheels are of the same size, 80mm in diameter with a cast iron rim.

##### ***3.1.5. Frames and Supports***

Flat iron sheets made of mild steel was used in constructing the frame and an angle iron sheet was also used to secure components on the bed of the lawnmower.

### **3.1.6. Pulley**

This is incorporated in the rotating assembly; it is keyed to the study of the electric motor and also serves as an attachment for the spinning rotary blade. It has an internal diameter of 20mm and an external diameter of 50mm.

### **3.1.7. Rotary blade**

This is the metallic spinning object that is attached to the stud of the motor and mows the grasses in the lawn. It is made of plain carbon steel. It is tilted to give an effective mowing.

### **3.1.8. Handle**

This serves as a holder for the user of the mower in the course of pushing the lawn mower while mowing. It is a 25mm rectangular hollow pipe made of mild steel.

## **3.2 Machine Fabrication**

The flat iron sheet was cut to specifications to make frames and supports which were welded together. The angle iron was used to secure the components (inverter and battery) on the bed of the machine. The components (inverter and battery) were also hooked to the bed of the machine with the aid of a plate, a rectangular pipe and fasteners (bolt and nuts) to avoid the components from vibrating when using the machine.

The prime mower was secured to the bed with the aid of bolts and nuts, and a hole was drilled using a drilling machine on the plate. The prime mower is placed on the plate in such a way that the stud goes straight into the drilled hole. Then the pulley was keyed with the aid of a square key to the stud of the electric motor.

A 2mm plate cut and shaped into the required shape, tilted to the required profile of the rotary blade to give the effective cut when mowing. This blade was sharpened at both adjacent ends that are required when mowing. Two holes were drilled in the centre of the blade, where it is been attached with bolts to the pulley keyed to the stud of the electric motor. The blade only covers the lateral span of the bed of the machine. The wheels were welded to the plate i.e the bed of the machine at the required point of the plate as specified in the diagram. The front two wheels are of a straight one which cannot revolve while the two at the rear are the revolving one that aids the maneuvering of the lawnmower in the course of approaching a bend.

The handle is made up of 25mm pipe which is welded into the required shape and also welded at an angle  $57^{\circ}$  to the surface of the bed at each side of the plate using electric arc welding. The hollow pipe is a rectangular one made of mild steel.

## **3.3 Machine Design Analysis**

The whole assembly is made up of several parts as analyzed below;

### **3.3.1. Choice of Prime Mower**

The inverter was used to power the motor which was selected for this design. The power rating of the motor at no load condition was 0.37KW (0.5HP) at 2850rev/min. The motor is lightweight and it was mounted vertically on the machine frame, i.e. it is of vertical shaft.

### **3.3.2. Prime Mower Analysis**

The shaft from the motor transmits the speed and torque directly to the rotary blade through the keyed wheel coupled to the end of the motor shaft (stud). The wheel was coupled to the shaft with the aid of a key and keyway.

### 3.3.3. Motor Pulley Key Design

Keys were used on shaft to secure rotating elements such as the wheels on the shaft. Keys were used to enable the transmission of torque from the shaft to the shaft supported elements and also the key ways on the shaft reduces the stress concentration on the shaft. Figure 1 showed Motor: Pulley and Key Diagram

The most commonly used types of keys are square key, flat key, Gib-head key, woodruff key and round key. Square key was employed for this design.

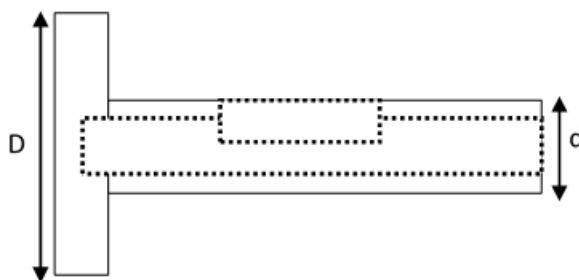

**Figure 1** Motor. Pulley and Key Diagram

Figure 1: Motor. Pulley and Key Diagram's equation

$F_1$ =Axial Force

L=Length of the key

W=Width of the square key (to thickness)

T=Torque

d=Diameter of the shaft (Motor)

D=Diameter of the wheel

q = Shear stress

For a key and shaft of the same material, the torque that a shaft of diameter 'd' can transmit allowing 25% reduction due to stress concentration is given by

$$0.75q = \frac{16T}{\pi d^3} \quad .3.1$$

$$q = \frac{16T}{0.75\pi d^3} \quad .3.2$$

Also, the shear stress a key can sustain is given by

$$q = \frac{F}{A} = \frac{F}{wld} \quad .3.3$$

Equating the equation 3.2 and 3.3

$$\Rightarrow \frac{16T}{0.75\pi d^3} = \frac{F}{wld}$$

$$\Rightarrow 0.75 \pi d = 4L$$

$$\Rightarrow L = \frac{0.75\pi d}{4}$$

And d = 20mm (diameter of motor shaft)

$$\Rightarrow L = \frac{0.75\pi \times 20}{4} = 11.8\text{mm}$$

$$\text{Since, } W = t = \frac{d}{4} = \frac{20}{4} = 5\text{mm}$$

Hence, the length of the key and key way is 11.8mm

The width of the square key is 5mm

### 3.4. Motor pulley Analysis

The motor wheel was connected directly to the motor shaft (stud). The motor wheel is a stepped one in which the smaller part is in contact with the motor shaft while the rotary blade is secured on the bigger part of the stepped wheel. For the wheel to be secured firmly on the motor shaft, the diameter of the wheel hole must be closed to that of the motor shaft with a clearance of + (0.2 – 0.5) mm.

And the outside diameter (D) of 60mm diameter is used; in which the rotary blade will be secured is as shown in Figure 2.

i.e. the inner diameter of the wheel is 20.4mm to be precise

Outside diameter of wheel is 60mm

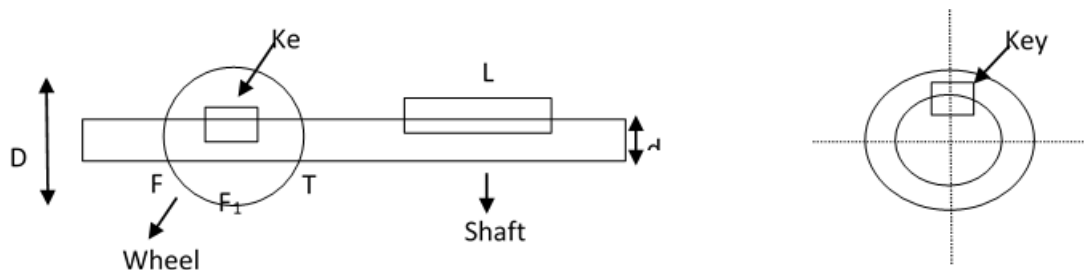

Figure 2 Motor Pulley Diagram's equation

#### 3.4.1. Transmitted Torque Analysis

Torque is given as  $T = \frac{60P}{2\pi N}$

Where  $T$  = Transmitted torque (Nm)  
 $P$  = Motor Power output (W)  
 $N$  = Speed of Motor (rev/min)

From the rating of the motor

$$P = 0.37\text{kw} = 370\text{w}$$

$$N = 2850 \text{ rev/min}$$

$$\text{The torque } T = \frac{60 \times 1100}{2\pi \times 2850} = 1.24\text{Nm}$$

### 3.5. Rotary Blade Weight Analysis

Since the torque from the motor is transmitted directly to the rotary blade, the two forces on the rotary assembly i.e. the rotary blade and the wheel need to be determined as shown in Figure 3.

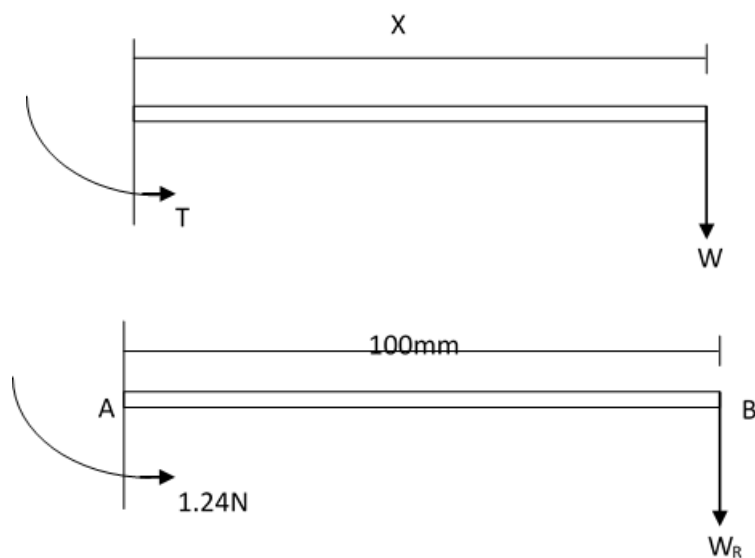

**Figure 3** Rotary Assembly Diagram's equation

X =length of the motor shaft= 100mm

T =Torque developed by the motor = 1.24Nm

WR = weight or force on the rotary assembly =?

Taking moment about point A,

$$\Rightarrow 1.24 - W_R \times 0.1 = 0$$

$$\Rightarrow W_R = 1.24/0.1 = 12.4N$$

Hence, maximum weight of the wheel and the rotary blade is 13N.

### 3.6. Thickness of Frame Base (bed)

The frame base of this machine serves as a carriage for every component that makes up the machine components like inverter, motor, rotary blade, etc. The thickness is selected in order not to shear under the stress at different sections of loading or attachment of components.

Considering the weights of all the components on the frame base, an angle iron with the thickness of 3mm is used which will support any form of shearing forces from the components.

Furthermore; rectangular hollow pipe of 25 mm is selected for the handle of the machine.

### 3.7 Inverter Rating Analysis

The rating of the selected motor (0.37KS7W) and allowance for the factor of safety will determine the rating of the inverter that will be required.

Since 0.37KW (0.5HP) of motor is used, for safe running of the motor according to the Institute of Electrical Engineers (IEE); the starting load from a power source (inverter in this case) must be 300% of the power rating of the motor.

Then, the rating of the inverter will be;  $3 \times 0.37 = 1.1KW$

This implies that a minimum rating for this design is 1.1KW.

Hence, 2KVA inverter is selected for the smooth running of the lawnmower considering the factor of safety.



### 3.8 Battery Rating Analysis

Battery voltage = 12V, 24 Amp hr

The load on the battery (motor load) = 370w

Rating of inverter = 2KVA

Amp hour of a battery =  $\frac{\text{Total load on battery}}{\text{Battery voltage}}$

$$= \frac{370}{12}$$

$$= 30.83\text{Ah}$$

Rating of battery to be used selecting 2 hours for the duration of using the lawnmower,

$$= \text{time of use} \times \text{Amp hour rating of battery}$$

$$= 2 \times 30.83$$

$$= 61.7\text{Ah}$$

Hence, a battery of 12V, 60Ah was selected for this design. However; the electric motor is shown in Figure 5a; the Electric circuit connection diagram is as shown in Figure 5b; and the side view of the machine is shown in Figure 6.

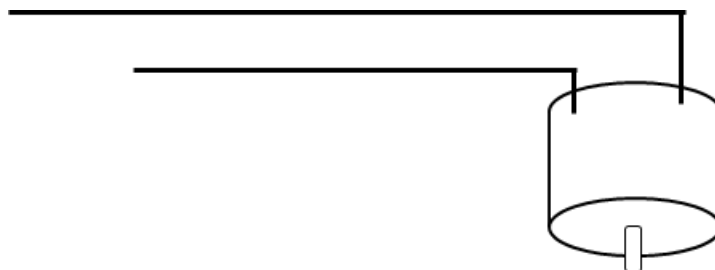

Figure 5a: Electric Motor

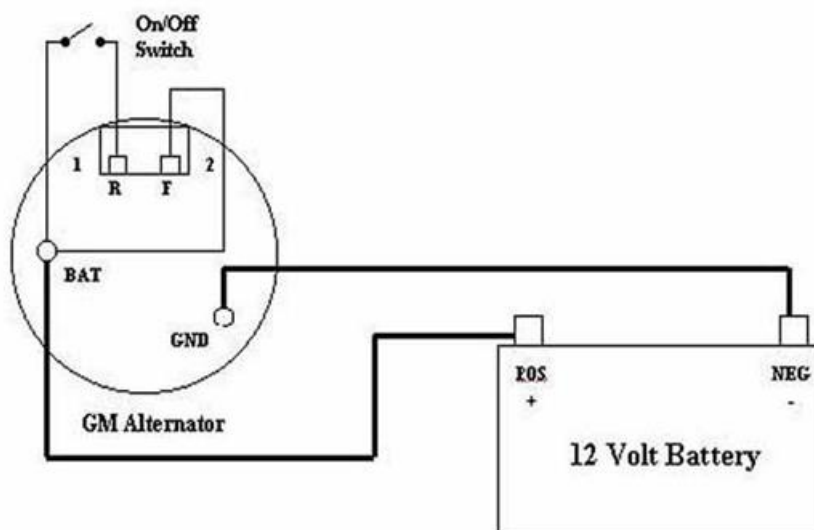

Figure 5b Electric circuit connection diagram

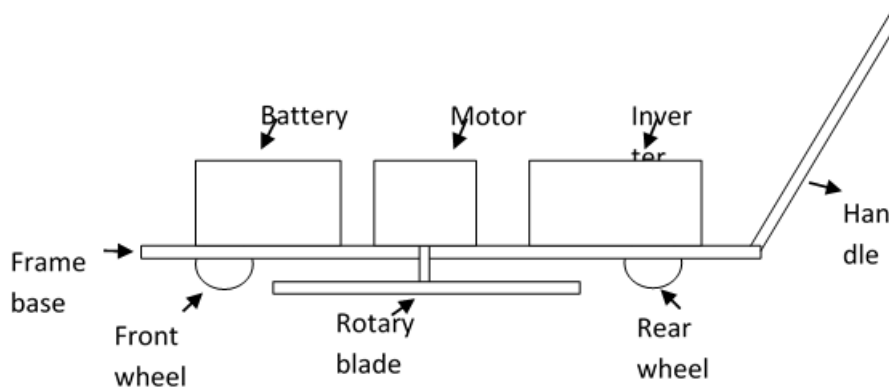

Figure 6 Side View of the Machine

### 3.9. Weight Analysis on the Support Wheels

The wheel of the lawnmower serves as a support to all the components on the frame base of the machine and it also cause the movement of the machine. The reactions on the wheel can be calculated to know the strength of the wheel that will be required as shown in Figure 4.

Considering the arrangement below for the components of the machine [9].

The free body diagram is as below;

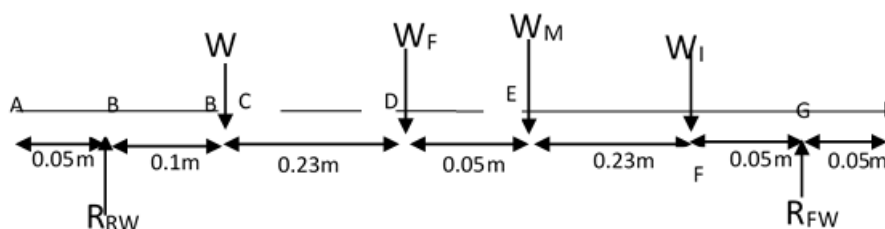

Figure 4 Free Body Diagram of the Machine

Where;

$W_B$  = weight of the battery = 80N

$W_I$  = weight of the inverter = 68N

$W_M$  = Weight of the motor and blade assembly = 49N

$W_F$  = Weight of the frame base = 75N

$R_{WF}$  = Reaction on the front wheels = ?

$R_{WR}$  = Reaction on the rear wheels = ?

Neglecting the effect of the handle on the frame base (bed),

Taking moment about point B;

$$\Rightarrow 68 \times 0.1 + 75 \times 0.33 + 49 \times 0.38 + 80 \times 0.61 - R_{WF} \times 0.66 = 0$$

$$\Rightarrow R_{WF} = \frac{98.97}{0.66} = 150N$$

Summation of all vertical forces,

$$\Rightarrow 68 + 75 + 49 + 80 - R_{WF} - R_{WR} = 0$$

$$\begin{aligned} \Rightarrow R_{WR} &= 272 - R_{WR} \\ &= 272 - 150 \\ &= 122\text{N} \end{aligned}$$

This implies that the wheels at the front must be able to resist a minimum force of 150N and the wheels at the rear must be able to resist minimum force of 122N.

For the bending moment and shear force diagram,

Bending moment on point A

$$BM_A = 0\text{Nm}$$

Bending moment on point B

$$BM_B = 122 \times 0 = 0\text{Nm}$$

Bending moment on point C

$$BM_C = 122 \times 0.1 = 12.2\text{Nm}$$

Bending moment on point D

$$BM_D = 122 \times 0.33 - 68 \times 0.23 = 24.6\text{Nm}$$

Bending moment on point E

$$BM_E = 122 \times 0.38 - 680 \times 0.28 - 75 \times 0.05 = 23.57\text{Nm}$$

Bending moment on point F

$$BM_F = 150 \times 0.05 = 7.5\text{ Nm}$$

Bending moment on point G

$$BM_G = 150 \times 0 = 0\text{Nm}$$

Bending moment on point H

$$BM_H = 0\text{Nm}$$

## 4. RESULTS AND DISCUSSION

### 4.1 Machine Operation

Power to drive the machine is inputted as the inverter is switched on, the direct current from the battery flows into the inverter, where it is converted into an alternating current and it is stepping up with the aid of the transformer in the inverter to give the required current to start the prime mover. The motor starts to work and its speed is accelerated at or above the speed at which the pulley is driven (about 2800rpm).

The torque from the prime mover is transmitted to the rotary blade via the motor pulley and causes the blade to spin which in turn gives the required mowing process when it comes into contact with the grasses on the lawn.

The machine is set into motion by human, pushing with the aid of the handle over all the space covered with the grasses on the lawn. This machine can work for hours until the battery discharge or run off completely. The battery needs to be recharged before it can be used again. The Side View of the Machine constructed is shown in Figure 7.



**Figure 7** Side View of the Constructed Machine

#### 4.2. Testing

Two conditions (height and toughness) of grasses were used to test the machine. These were judged based on the nature, state or category, type of grasses namely, the soft and stubborn grasses. Grasses of height between 30 to 100mm and soft stems were practically and appreciably mowed compared to tall and tough grasses.

The efficiencies are determined as follows:

- a) Performance (cutting) efficiency on stubborn grasses

$$\frac{\text{Portion cut by lawnmower}}{\text{Portion of lawn}} \times 100$$

- b) Performance (cutting) efficiency on stubborn grasses

$$\frac{\text{Portion cut by lawnmower}}{\text{Portion of lawn}} \times 100$$

#### 4.3. Discussion

It could be inferred from the results from the two tables that the machine has a better performance efficiency on soft grasses than the stubborn grasses.

As calculated in section 3.9 (Weight Analysis on the Support Wheels), it is shown that the components have some effects on the bed of the machine and this necessitate the force and bending moment's calculation. It is shown from the calculation that the supports for the bed of the machine (wheels) should be a minimum force of 150N and 122N on the front and rear wheels respectively. This keeps the machine to move perfectly when it is in use. Tests on the machine constructed and its performance efficiency is as shown in Tables 1 and 2 respectively.

## Construction of Inverter Powered Lawn Mower

**Table 1** Performance efficiency of the Mower for soft grasses

No of trials	Portion of lawns (m <sup>2</sup> )	Portion of cut by lawnmower (m <sup>2</sup> )	Portion uncut by lawnmower(m <sup>2</sup> )	Performance efficiency (%)
1	50.00	36.6	13.4	73.2
2	60.00	41.8	18.2	69.7
3	55.00	43.7	11.3	79.4

**Table 2** Performance efficiency of the mower for stubborn grasses

No of trials	Portion of lawn (m <sup>2</sup> )	Portion of cut by lawnmower (m <sup>2</sup> )	Portion uncut by lawnmower (m <sup>2</sup> )	Performance efficiency (%)
1	40	24.5	15.5	61.3
2	50	29.1	20.9	58.2
3	45	25.1	19.9	55.7

## 5. CONCLUSION

An inverter powered lawn mower was designed and constructed. The constructed lawn mower was used to mow the lawn at the Engineering park at Ladoke Akintola University of Technology, Ogbomosho, Oyo State, Nigeria. The inverter powered lawn mower was operated at a speed of 0.4ms-1seconds; the lawn mower must cover a distance of 1m in 2.5 seconds for an efficient mowing. The machine has a noticeably high efficiency on soft grasses and an average efficiency on stubborn grasses, but works better on “maintained” lawns with soft grasses to a very precise and consistent level. The machine is economically feasible with high mechanical simplicity.

## REFERENCES

- [1] David G. and Halford K., Old Lawn Mower-Shine Publication Ltd. 2001. Design of lawnmower Retrieved from [http://www. Instrucable.com/id/solar-lawnmower](http://www.Instrucable.com/id/solar-lawnmower).
- [2] Dore S. and Lawson A. (2003), push for more efficient mowers. Electric motor load and inverter rating calculation Retrieved from [www.novaelectric.com/inverter\\_faqqhp](http://www.novaelectric.com/inverter_faqqhp).
- [3] Peter, P.W. (2003): “Mowing tips”, Retrieved December 13, 2003 from Rating of inverter and load retrieved from <http://www.google.com/patents/about>
- [4] Bob,B.T(1999):“Mowingtips”,Retrieved December13, 2003.
- [5] American Lawn Mower Company (2003): “Mowing tips”, Retrieved December 13, 2003 from <http://www.reelin.com/anadvant.htm>.
- [6] Dona, D. L (1997): Mowing tips”, Retrieved December 13, 1997 from <http://www.reelin.com/anadvant.htm>
- [7] Dona, D.L(2006): Mowingtips” Retrieved June 16, 2007 from <http://www.reelin.com/anadvant.htm>
- [8] Hessayon, D.G. (1996): The Lawn Export Trans World Publishers, London.Lawn and its maintenance, Retrieved <http://www.forums2.gardenweb.com.forums/load>.
- [9] Calculations on fabrication of lawnmower retrieved from Mowing and maintenance of mowers [http://www.wn.com/lawn\\_mower\\_generator\\_with\\_12](http://www.wn.com/lawn_mower_generator_with_12).Retrieved 2003.