

Application of MIMO Technology to Systems Beyond 3G

Ibikunle Frank* and Olowononi Felix*

* Department of Electrical and Information Engineering, Covenant University, Nigeria

Article Info

Article history:

Received Sept 05th, 2012

Accepted Sept 24th, 2012

Keyword:

LTE

MIMO

Multiple-antenna technology

Mobile communication systems

Spectral efficiency

ABSTRACT

The evolution of mobile Broadband over the years has been phenomenal and worthy of attention by academics, researchers, the corporate world and users alike. From the days of the First Generation (1G) through the Third Generation (3G) communication systems, the evolution has continued and has been largely influenced by an ever increasing demand for improved services and greater capacity evident in higher data rates, wider and improved coverage, improved spectral efficiency and lower latency. In response to these demands and to address some of the loopholes of the 3G networks, the 3rd Generation Partnership defined the Long Term Evolution (LTE). LTE though an evolving technology is widely accepted due to its unprecedented promised performance. As the evolution continues, the design of the 'LTE-Advanced' is already in progress and has been tagged different names such as the '4G' and 'Beyond 3G' (B3G). The main backbones behind these evolutions are technological developments in the underlying mobile radio technology such as multicarrier technology (majorly OFDMA), multiple-antenna technology (MIMO) and the application of packet-switching to the radio-interface through improvements in techniques like adaptive scheduling in both the frequency and spatial dimensions, link adaptation of modulation and code-rate and several modes of fast channel state reporting. This paper is set to present the multiple antenna technology and how it contributes to the delivery of the expectations of the wireless communication systems beyond 3G

Copyright © 2012 Institute of Advanced Engineering and Science.
All rights reserved.

Corresponding Author:

Ibikunle Frank,

Departement of Electrical and Information Engineering,

Covenant University, Nigeria

Email:faibikunle2@yahoo.co.uk

1. INTRODUCTION

The reliability of the air interface has always been a major issue in the design of wireless systems. Due to the presence of many impediments along the route a signal travels from the transmitter to the receiver, interference and fading are two great factors affecting the efficiency of mobile communication systems. For decades, 'Shannon capacity formula' for a single radio link was considered the upper-bound on data rates which could be transmitted in a given channel [1]. The Shannon bound which is the maximum rate at which reliable communication can take place in the channel provided the motivation for coding. Advances in coding techniques made technologies such as Wideband Code Division Multiple Access (WCDMA) come close to achieving the upper-bound of data rates proposed by Shannon. However, in the past two decades, much effort has been put forth by researchers in extending this theory to communication by involving a multiplicity of transmit and receive antennas to further push the bounds of feasible data rates still further. The inherent value of multiple antenna systems as a means to improve communications was first proposed in the early days of the wireless communication. However, considerable scientific progress in research and in implementation of this technology only gained prominence in the last twenty years as a result of discoveries in digital signal processing and information theory. The key milestone achieved was the invention of the MIMO systems in

the mid-1990s and serious attention has been paid to the utilization of multiple-antenna techniques in mass-market commercial wireless networks since the turn of the new millennium. Today, the key role which MIMO technology plays in the latest wireless communication is evident in its adoption for the first time in a cellular mobile network standard in the Release 7 version of HSDPA and LTE which is the first global mobile cellular system to be designed with MIMO as a key component from the start. MIMO provides a way of utilizing the multiple signal paths that exist between a transmitter and receiver in terrestrial communications to significantly improve the data throughput available on a given channel with its defined bandwidth. By using multiple antennas at the transmitter and receiver along with some complex digital signal processing, MIMO technology enables the system to set up multiple data streams on the same channel, thereby increasing the data capacity of a channel rather than causing interference.

2. CAPACITY CHALLENGES IN NETWORKS FROM 1G TO 3G

The basic challenge of mobile wireless networks is that of capacity as bandwidth or spectrum is finite and hence limited in availability for the different operators. As a result of the convergence of voice, video and data on the same network, newer applications keep developing which in turn is creating an insatiable desire for high data rate and high link qualities. Various methods have been utilized by different telecommunication technologies to tackle the problem of bandwidth limitation by optimizing what is at their disposal. The problem of capacity limitation began with the first generation networks like Advanced Mobile Phone System (AMPS) and Total Access Communication Systems (TACS) which were analogue technology and utilized circuit switching for voice communication only. However, as the second generation networks like GSM was introduced with ability to roam, send texts and also operate as a packet switching technology, the capacity and spectral efficiency became a major issue of concern [2].

One of the methods developed to combat the capacity problem is the *Frequency Reuse System*. The major advantage of cellular radio lies in the frequency reuse concept. Channels used at one cell site may be used again at other cell sites, thereby increasing the capacity of the system. However, these channels can only be used if the separation between co-channel cells is sufficient enough to avoid the appearance of interference. The minimum distance that allows the use of the same frequency is called frequency reuse distance and is dependent on the system's design and the terrain contour of the geographical area to be covered. Frequency reuse increases the system's spectrum efficiency provided the phenomenon of Co-Channel Interference (CCI) can be mitigated. Frequency Hopping can also be used to enhance capacity in GSM networks and operates by addition of transceivers to existing cells. With frequency hopping, frequency diversity occurs, which balances the quality between slow and fast moving users [3].

Another method utilized in cellular systems to enhance capacity is the sectorization of cells. *Cell-sectoring* makes effect on Interference Power, Spectrum Efficiency and Signal-to-Interference Ratio (SIR). It operates on a principle of keeping the cell radius unchanged but reducing the number of cells in a cluster thus increasing the frequency reuse. One way to achieve this is by replacing a single omni-directional antenna at the base station by several directional antennas. With this method, a cell is divided into a number of sectors, each of which is served by a different set of channels and supervised by a directional antenna. Directional antennas allow the co-cells to be more closely spaced, and eliminate the co-channel interference effects. The factor by which the co-channel interference is reduced depends upon the amount of sectoring used with a typical cell normally partitioned into three or six sectors. When sectoring is employed, the channels used in a particular cell are broken down into sectorized groups, and are used only within a particular sector. However, the impact of the resulting capacity improvement is an increased number of antennas at the base station, as well as the number of handovers [4].

Cell Splitting is another method of handling capacity problems and refers to the process where a cell is divided into smaller ones, each of which has its own base station. In general, cell splitting increases the number of channels per unit area by decreasing the cell radius and keeping the co-channel reuse factor unchanged.

Another method to enhance capacity and hence accommodate more users is the concept of *Multiple Access*. Previous methods that have been exploited in mobile communications in the first to third generation systems include frequency division multiple access, time division multiple access and code division multiple access as illustrated in Figure 1.

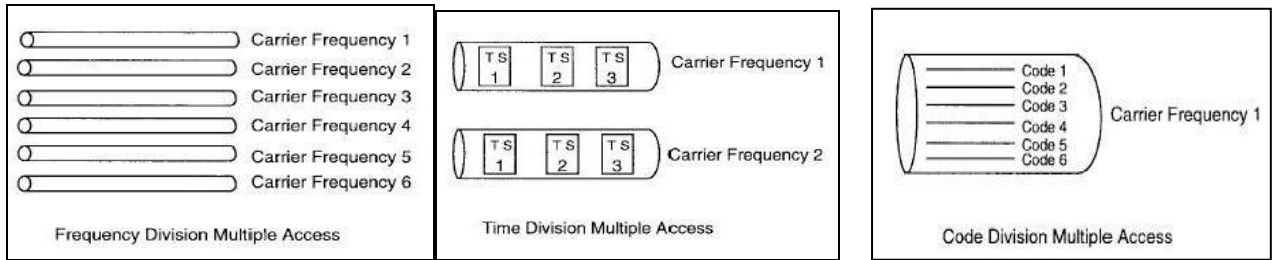

Figure 1. Types of Multiple Access

The present and dominant forms of multiple access utilized in Next Generation Networks include the Orthogonal Frequency Division Multiple Access (OFDM) and the Space Division Multiple Access (SDMA).

3. MULTIPLE-ANTENNA SYSTEMS

All radio communications systems, regardless of whether mobile radio networks like 3GPP UMTS or wireless radio networks like WLAN, must continually provide higher data rates. In addition to conventional methods, such as introducing higher modulation types or providing larger bandwidths also being achieved by using multiple antenna systems. There are four classes of multiple antennas namely Single Input -Single Output (SISO), Single Input - Multiple Output (SIMO), Multiple Input -Single Output (MISO) and Multiple Input - Multiple Output (MIMO). This classification is based on the number of antennas at the transmitting and receiving ends.

3.1 Single Input -Single Output (SISO)

In conventional wireless communications, a single antenna is used at the source and another single antenna is used at the destination. This type is referred to as a single input -single output (SISO) system. In this system, the signal or wave-front is transmitted in all directions and the receiver antenna listens to signals coming from all directions. Sending signals by transmitting energy in all directions is not energy efficient. Another drawback with SISO systems is that they are vulnerable to multipath effects because when the electromagnetic wave-front travels towards the receiver, its propagation path can be obstructed by objects such as hills, buildings and trees. The wave fronts will then be reflected and scattered by these objects, thus creating multiple paths to the receiver. The wave-front, arriving in scattered portions at different time instances, can cause problems resulting in intermittent reception. In digital communications this can cause an increase in the number of errors resulting in a reduction in data rate.

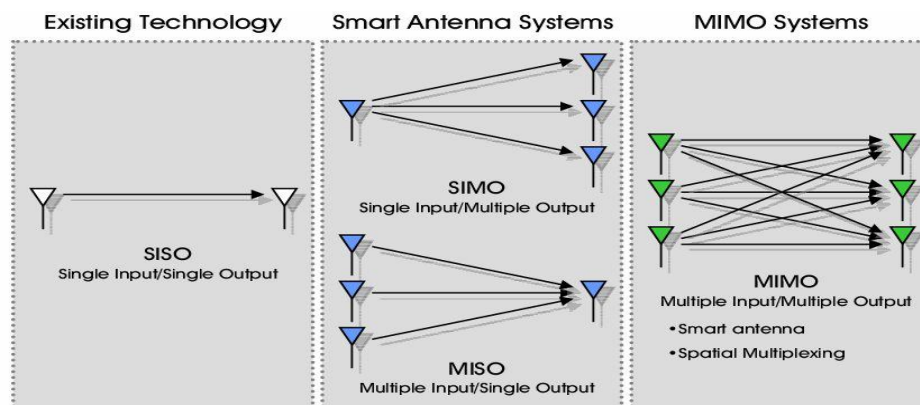

Figure 2. Classes of Multiple Antenna Technologies

3.2 Single Input-Multiple Output (SIMO)

In a SIMO system, one antenna is used at the transmitter, and two or more antennas are used at the receiver. This however is not common in mobile communication due to concerns about the possibility of integrating one antenna in a single user equipment and the associated challenges.

3.3 Multiple Input - Single Output (MISO)

In a MISO system shown in Figure 3, two or more antennas are used at the transmitter, and one antenna is used at the receiver. Through the application of this technique, it is possible to transmit in a specific direction or listen in a specific direction. The smart antenna system detects multi-paths and creates “listening” beams for those directions while other signals are suppressed. In this way, the signals coming from the directions of the listening beams can be combined at the receiver, thus increasing the signal-to-noise ratio (SNR) and lowering the bit error rate (BER). The concept of using smart antennas to transmit and receive data more intelligently has existed for many years. Simple smart antenna techniques, like the switched beam technology, where the antenna systems form multiple fixed beams with heightened sensitivity in particular directions have been used in commercial applications for some time. These antenna systems detect signal strength, choose from one of several predetermined, fixed beams, and switch from one beam to another as the mobile device moves throughout the beam pattern.

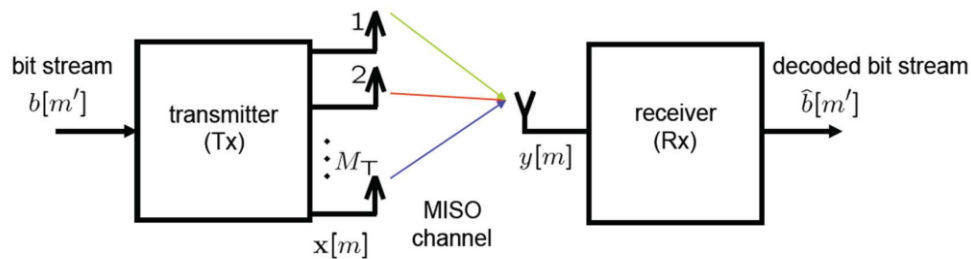

Figure 3. A Multiple Input Single Output (MISO) system

3.4 Multiple Input Multiple Output (MIMO)

MIMO systems are characterized by having multiple antennas at both the transmitter and the receiver. The number of antenna elements does not have to be the same at the transmitter and the receiver. A MIMO system is mainly used for three different purposes; beam forming, diversity, and spatial multiplexing. MIMO technology offers a number of benefits over conventional single-input single-output (SISO) systems that help to meet the challenges posed by both the impairments in the wireless channel as well as the strict resource (power and bandwidth) constraints. MIMO systems gain their popularity in the exploitation of the spatial domain inherent in the use of multiple spatially distributed antennas. Other technologies capitalized only on the time and frequency dimensions which are the natural dimensions of digital communication data.

4. BENEFITS OF MIMO TECHNOLOGY

In general, the benefits of MIMO in wireless systems include the possibility of larger data rate, larger spectral efficiency, large number of user, improved range/coverage distance, better interference suppression, better Quality of Service (QoS), lower bit-error rate and lower transmission power. From another perspective, MIMO channels provide a number of advantages over conventional SISO channels such as the array gain, the diversity gain and the multiplexing gain [5]. Research has proven that while the array gains and diversity gains are not exclusive to MIMO communication channel or systems only as they also exist in Single-Input Multiple-Output (SIMO) and Multiple-Input Single-Output (MISO) channels, the multiplexing gain is a unique characteristic of MIMO channels.

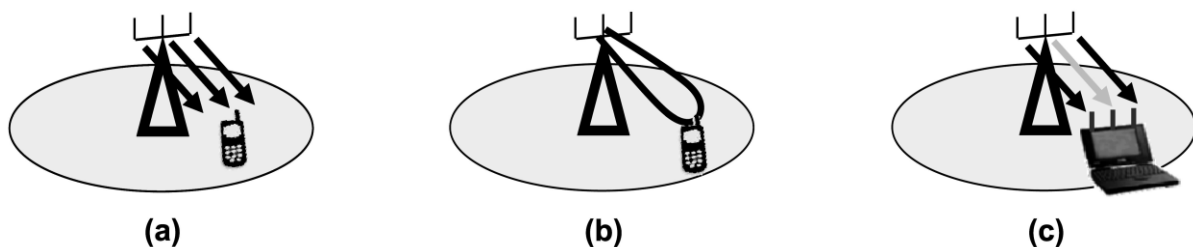

Figure 4. Benefits of multiple antennas: (a) diversity gain; (b) array gain; (c) spatial multiplexing gain

The Array gain as shown in Figure 4(b) primarily refers to the improvement in receive signal-to-noise ratio (SNR) that results from a coherent combining effect of the information signals. The coherent combining may be realized through spatial processing at the receive antenna array and/or spatial pre-processing at the transmit antenna array. In other words, array gain simply refers to the concentration of energy in one or more given directions via pre-coding or beam-forming. This also allows multiple users

located in different directions to be served simultaneously. Transmit/receive array gain requires channel knowledge in the transmitter and receiver, respectively, and depends on the number of transmit and receive antennas. Channel knowledge in the receiver is typically available whereas channel state information in the transmitter is in general more difficult to maintain.

The second gain of implementing MIMO technology is for the purpose of *diversity gain*. As earlier discussed, fading and interference are the most significant challenges associated with wireless communication systems (terrestrial communication systems). Diversity is a powerful technique to mitigate the random fluctuation or fading of signal power in wireless channels/links.

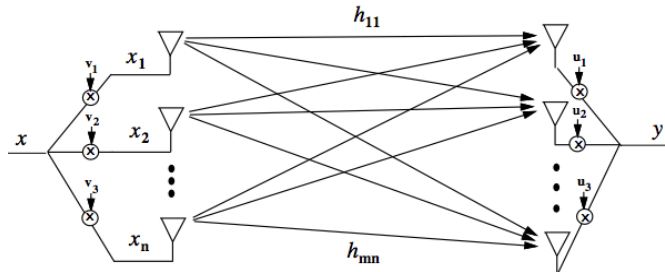

Figure 5. Illustrating the diversity gain

Diversity techniques function by transmitting the signal over multiple independently fading paths in time, frequency and space as shown in Figure 4(a). Spatial (or antenna) diversity is preferable to time diversity and frequency diversity in that it does not incur expenditure in transmission time or bandwidth. If the links comprising the MIMO channel fade independently and the transmitted signal is suitably constructed, the receiver can combine the arriving signals such that the resultant signal exhibits considerably reduced amplitude variability in comparison to a SISO link as shown in Figure 4(c). Extracting spatial diversity gain in the absence of channel knowledge at the transmitter is possible using suitably designed transmit signals. The corresponding technique is known as space-time coding. In summary, the diversity gain involves the use of the space-diversity provided by the multiple antennas to improve the robustness of the transmission against multipath fading.

In a system with multiple transmit and receive antennas, each pair of transmit-receive antenna provides a signal path from the transmitter to the receiver. Therefore, by sending the same information through different paths, multiple independently-faded replicas of the data symbol will be obtained at the receiver end. This process therefore guarantees that a more reliable reception is achieved and that the probability of error is reduced. It has been shown that the higher the diversity gain, the lower the Probability of error (P_e).

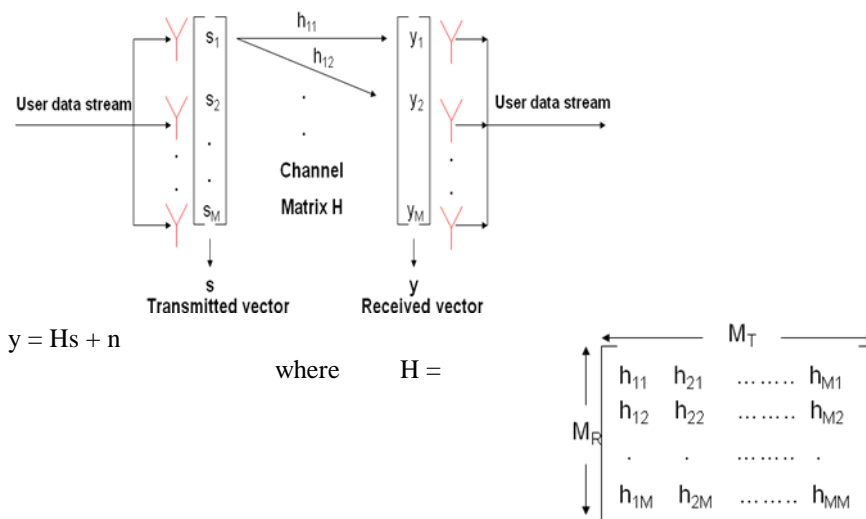

Figure 6. MIMO Antenna Configuration

h_{ij} is a Complex Gaussian random variable that models fading gain between the i_{th} transmit antenna and the j_{th} receive antenna

To further prove the advantage of MIMO systems over SISO systems, a diversity gain d implies that in the high SNR region, the P_e of a MIMO system decays at a rate of $1/(\text{SNR})^d$ as opposed to $1/\text{SNR}$ for a SISO system. From Figure 5, the maximal diversity gain d_{max} is the total number of independent signal paths that exist between the transmitter and receiver. For an (M_R, M_T) system, the total number of signal paths is $M_R M_T$ as depicted in Figure 6.

Another reason for the widespread acceptance of MIMO technology comes from the perspective of spatial multiplexing. *Spatial multiplexing gain* is evident in a linear increase in capacity for no additional power or bandwidth expenditure and is attained by the transmission of multiple independent data signal streams to a single user on multiple spatial layers created by combinations of the available antennas. Under conducive channel conditions, such as rich scattering the receiver can separate the different streams, yielding a linear increase in capacity.

The final benefit of deploying MIMO systems is in its ability to reduce interference. Co-channel interference arises due to frequency reuse in wireless channels. When multiple antennas are used, the differentiation between the spatial signatures of the desired signal and co-channel signals can be exploited to reduce interference. Interference reduction requires knowledge of the desired signal's channel. Exact knowledge of the interferer's channel may not be necessary. Interference reduction (or avoidance) can also be implemented at the transmitter, where the goal is to minimize the interference energy sent towards the co-channel users while delivering the signal to the desired user. Interference reduction allows aggressive frequency reuse and thereby increases multi-cell capacity.

4.1 Transmit Diversity Versus Spatial Multiplexing (A fundamental Trade-off)

It is not possible to exploit all the leverages of MIMO technology simultaneously due to conflicting demands on the spatial degrees of freedom (or number of antennas). The degree to which these conflicts are resolved depends upon the signaling scheme and transceiver design [6]. With the advent of MIMO, a choice needs to be made between transmit diversity techniques, which increase reliability (decrease probability of error) and spatial multiplexing techniques, which increase rate but not necessarily reliability. Applications requiring extremely high reliability seem well suited for transmit diversity techniques whereas applications that can smoothly handle loss appear better suited for spatial multiplexing. It may further appear that the SNR (signal-to noise ratio) and the degree of channel selectivity should also affect this decision. Essentially, different design criteria of MIMO communication schemes are based on exploiting the previous gains, especially the spatial diversity and multiplexing gains. Actually, both perspectives come from different ways of understanding the ever-present fading in wireless communications.

Traditionally, fading is considered as a source of randomness that makes wireless links unreliable. In response, a natural attempt is to use multiple antennas for compensating the random signal fluctuations and achieving a steady channel gain. The spatial dimension is exploited in this case to maximize diversity. Each pair of transmit and receive antennas provides a different (possibly independent) signal path from transmitter to receiver. By sending signals that carry the same information over a number of different paths, multiple independent faded replicas of the data can be obtained at the receiver end, increasing the reliability of the reception process. Some examples of MIMO schemes which fall within this category are space-time codes and orthogonal designs. A different line of thought suggests that in a MIMO channel, fading can in fact be beneficial through increasing the degrees of freedom available for communication. Essentially, if the path gains between individual transmit and receive antenna pairs fade independently, the channel matrix is well-conditioned with high probability, in which case multiple spatial channels are created. Hence, the data rate can be increased by transmitting independent information in parallel through the available spatial channels.

In fact, given a MIMO channel, both the spatial diversity and the multiplexing gains can be simultaneously obtained, but there is a tradeoff between how much of each type of gain in any MIMO scheme can extract: higher spatial multiplexing comes at the price of sacrificing diversity. The complete picture of this tradeoff was given in [7], and it focuses on the high-SNR regime and provides the fundamental tradeoff curve achievable by any scheme, where the spatial multiplexing gain is understood as the fraction of capacity attained at high SNR and the diversity gain indicates the high-SNR reliability of the system. The two previously commented design strategies correspond to the two extreme points of the curve: maximum diversity and no multiplexing gain and maximum multiplexing gain and no diversity gain. The fundamental tradeoff curve bridges the gap between these two extremes and offers insights to understand the overall resources provided by MIMO channels [8].

5. SMART ANTENNAS

One of the most promising techniques for increasing the capacity in cellular systems is the use of *smart* or *adaptive antennas*[2]. The technology of smart or adaptive antennas for mobile communications has received enormous interest worldwide in recent years. In actual fact, development in the Smart Antenna concept led to the present concept of Multiple Input Multiple Output (MIMO) antenna system.

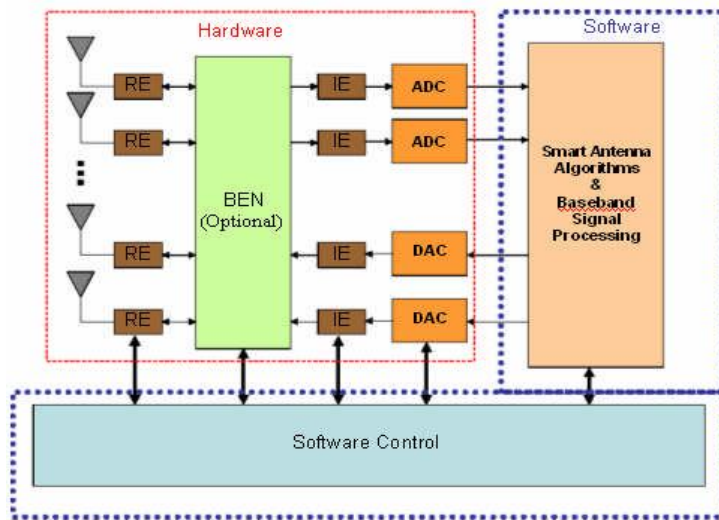

Figure 7. Block diagram of a Smart Antenna System

Prior to the present moment, base station antennas have been Omni-directional or sectored. Smart antennas are base station antennas with a pattern that is not fixed, but adapts to the current radio conditions. Smart antenna technology or adaptive antenna array technology enables the performance of the antenna to be altered to provide the performance that may be required to undertake performance under specific or changing conditions. This can be visualized as the antenna directing a beam towards the communication partner only. Smart antennas will therefore lead to a much more efficient use of the power and spectrum, increasing the useful received power as well as reducing interference. The smart antennas include signal processing capability that can perform tasks such as analysis of the direction of arrival of a signal and then the smart antenna can adapt the antenna itself using beam-forming techniques to achieve better reception, or transmission. In addition to this, the overall antenna will use some form of adaptive antenna array scheme to enable the antenna to perform is beam formation and signal direction detection. In the context of smart antennas, the term “antenna” goes beyond a radiating element to a complex system consisting of a number of radiating elements, a combining/dividing network and a control unit as shown in Figure 7. The control unit has the sole function of acting as the smart antenna’s intelligence and is normally realized using a digital signal processor (DSP). The processor controls feeder parameters of the antenna, based on several inputs, in order to optimize the communications link. With considerable levels of functionality being required within smart antennas, two main approaches or types of smart antenna technology have been developed which includes the switched beam smart antennas and the adaptive array smart antennas. The switched beam or adaptive array smart antennas are designed so that they have several fixed beam patterns. The control elements within the antenna can then select the most appropriate one for the conditions that have been detected. Although this approach does not provide complete flexibility it simplifies the design and provides sufficient level of adaptivity for many applications. Adaptive antenna arrays however allow the beam to be continually steered to any direction to allow for the maximum signal to be received and / or the nulling of any interference.

5.1 Smart Antenna Algorithms

Smart antennas linearly combine antenna signals into a weight vector that is used to control the beam pattern. The weights can be determined in a number of ways using different algorithms. These algorithms can be divided into three classes namely spatial reference, temporal reference, and blind algorithms. The spatial and temporal reference algorithm classes both form beam patterns and are based on linear weighting and addition of received signals at the antenna elements [9].

In Spatial reference algorithms (SR) the antenna weights are chosen based on knowledge of the array structure. These algorithms estimate the direction of arrival (DOA) of both the desired and interfering signals. The DOAs can be determined by applying different methods to the sampled data from the antenna array. The simplest way of extracting the DOAs is to use spatial Fourier transform on the signal vector. This method is limited by its resolution (size of antenna array) and has therefore limited usages. In cases where good resolution is necessary, so called high resolution methods could be used. High-resolution methods are limited only by the modeling errors and noise and not by the size of the antenna array. Common high-resolution algorithms include Minimum Variance Method (Capon's beamforming algorithm), MUSIC algorithm (determines the signal and noise subspaces and then searches the spectrum to find DOAs), ESPRIT algorithm (determines the signal subspace, from which the DOAs are determined in closed form) and SAGE algorithm (based on maximum likelihood estimation of the parameters of the impinging waves on the antenna array)[9]. When the DOAs are determined an appropriate beam pattern is created that maximizes the beam pattern in the direction of the wanted signals and places nulls in the direction of unwanted interfering signals.

Temporal reference algorithms (TR) are based on prior knowledge of the time structure of the received signals. Usually a training sequence is used as a temporal reference. The receiver aims to adjust or choose antenna weights such that the deviation of the combined signal at the output and in the known training sequence is minimized. The calculated weights are then used to form a beam pattern. The third class of algorithms termed *blind algorithms* is based on prior knowledge of the signal properties of the transmitted signal. Different algorithms can be used to determine the signal matrix for the received sample data depending on the statistical properties of transmitted signal in consideration.

5.2 Antenna Array Processing, Direction Finding and Beam Forming

Classical direction finding methods usually use several antennas or antenna arrays to measure phase differences while modern direction finding methods make use of all the information received on different elements of the antenna array. Before its widespread use in mobile communications, array signal processing had already found applications in radar, sonar and seismic exploration. However, next generations of wireless systems using multiple antenna arrays (or smart antennas) have brought about new technologies in the digital signal processing techniques due to their goal to intelligently enhance the desired signal and null or reduce interference.

Different algorithms for antenna array processing and direction finding has evolved as advances in Digital Signal Processing have enabled the use of new approaches for direction finding. The previous requirement for a simple and frequency-independent relationship between the signals obtained on antenna elements and the bearing no longer applies as complex mathematical relationships can be efficiently computed. High-resolution methods allow the separation of several waves arriving from different direction based on Direction of Arrival (DOA) estimation. DOA can be converted to direction relative to the true north after which the outputs of the individual antenna elements are taken to a network which contains test signal inputs and multiplexers and finally, the signals are then converted to an intermediate frequency and digitized. Conventional methods of DOA are based on the concept of beam forming which involves steering antenna array beams in all possible directions and looking for peaks in the output power. Furthermore, the antenna array signals u_i are multiplied by complex weighting factors w_i and added, a sum signal is obtained which depends on the direction of wave incidence. With conventional beam forming algorithms the phases of the weighting factors are chosen so that the weighted element signals are added in phase and thus yield a maximum sum signal for a given wave direction. This output signal is given by a weighted sum of the element input. The block diagram for the process of beam forming is shown in Figure 8.

$$y(k) = \sum_{i=1}^M w_i u_i = \mathbf{w}^H \mathbf{u}(k)$$

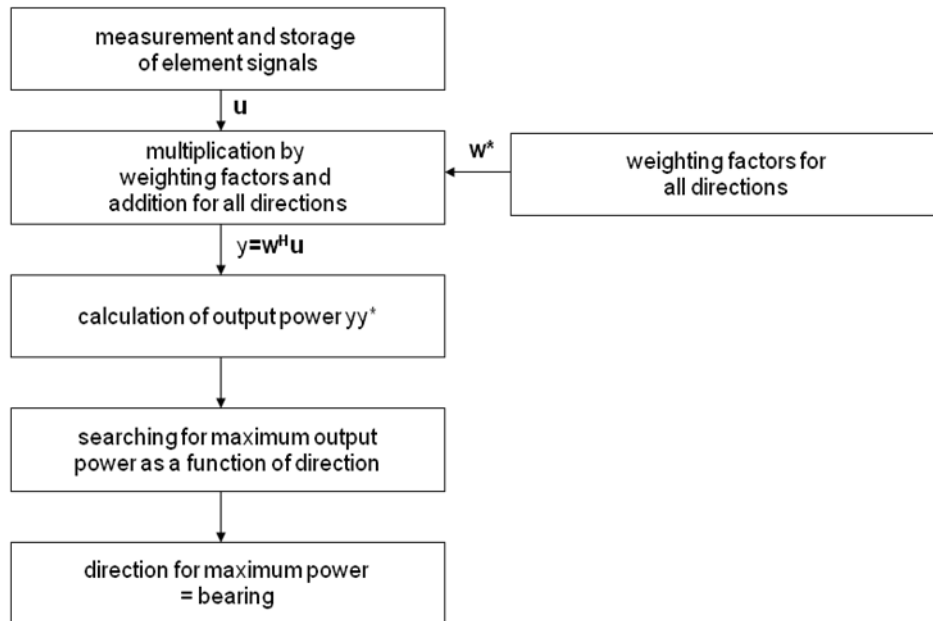

Figure 8. The process of beam forming

6. CHALLENGES OF UTILIZING MIMO IN COMMUNICATION SYSTEMS

The deployment of MIMO technology in systems beyond 3G (B3G) has its associated challenges or areas of concern. This can however be expected to be improved upon as the technology is continually utilized. The first challenge is that of hardware complexity which is borne out of the fact that each antenna needs a radio-frequency (RF) unit and also because a powerful digital signal processing (DSP) unit is required. Furthermore, the Software complexity is also another challenge for the designers as most signal processing algorithms are computationally intensive.

Other issues worthy of concern include an increased Power consumption evident in the reduced battery lifetime of mobile devices and the thermal energy radiated; antenna spacing challenge in order to keep the size of the mobile devices reasonable (electromagnetic mutual coupling-e.g. mobile handsets), RF interference and antenna correlation.

7. CONCLUSION AND FUTURE RESEARCH

The application of Multiple Antennas in telecommunication systems has helped a lot to achieve the goals of the Next Generation Networks (B3G). Despite the challenges involved, its use and success in the HSPA+ and LTE has proven that it is a technology to be reckoned with. With accompanying developments in digital modulation (especially 128-QAM) and other technologies, it can only be imagined what the future holds for users through the transformation that will follow.

However, there is still a lot of ground to be broken in this technology. Some of the areas where research is envisaged or ongoing include large MIMO (hundreds of low-power antennas (1mW) placed on a base station with potential for significant performance gains); MIMO relaying networks (combination of cooperative and MIMO technologies for increased capacity, reliability and coverage); Cognitive radio which detect ‘holes’ in the expensive spectrum; Heterogeneous networks which are a combination of Macrocell with Picocell and Femtocell; Multi-cell MIMO which refers to multiple Base Station Systems each equipped with multiple antennas and development of schemes for estimation of practical impairments like timing offset, frequency offset and phase shift that need to be estimated and compensated.

REFERENCES

- [1] Shannon C.E (1998), ‘A mathematical theory of Communication’, Bell Systems Technology Journal, Vol.27
- [2] Lehne P.H and Pettersen M, ‘An Overview of Smart Antenna Technology for Mobile Communication Systems’, IEEE Comms Surveys: *The Electronic Magazine of Original Peer-Reviewed Survey Articles*
- [3] Engstrom Stefan, Johansson Thomas and Kronstedt, ‘Multiple Reuse Patterns for Frequency Planning in GSM Networks’, IEEE 1998

- [4] Rappaport T, 'Wireless Communication', 2nd Edition, Prentice Hall, 2002
- [5] Stefania Sasia, Issam Toufik and Matthew Baker, "LTE- The UMTS Long Term Evolution: from Theory to Practice", John Wiley and Sons Limited, 2009
- [6] Lozano Angel and Jindal Nihar, 'Transmit Diversity vs Spatial Multiplexing in Modern MIMO System' *IEEE Transactions on Wireless Communications*, Vol 9, No 1, January 2010
- [7] Zheng L, and Tse D, 'Diversity and multiplexing: A fundamental tradeoff in multiple-antenna Channels', *IEEE Trans. Inform. Theory*, vol. 49, no. 5, pp. 1073-1096, May 2003.
- [8] Ordonez Luis Garcia, 'Performance Limits of Spatial Multiplexing MIMO Systems', PhD Thesis, March 2009
- [9] Harish Ganapathy, 'MIMO Systems; Basic Principles, Algorithms and Networking Applications'
- [10] Paulraj A, Nabar R, and Gore D, 'Introduction to Space-Time Wireless Communications' Cambridge University Press, 2003.

BIOGRAPHY OF AUTHORS

Ibikunle Frank Ayo

Ibikunle Frank Ayo (Ph.D), received his first degree in Electrical Engineering from University of Science and Technology, Port-Harcourt, Nigeria in 1986. In 1993, he won himself a Federal Government Scholarship award to study abroad and obtained a Doctorate degree in Telecommunications and Information Engineering (by research work) in 1997 from the University of Posts and Telecommunications, Beijing, China. He has 26 years practical working experience with the largest telecommunications carrier company in Nigeria (called NITEL) and the mobile arm of the NITEL Ltd. (called MTEL) before joining the academics. He is presently at Covenant University, Electrical and Information Department of the School of Engineering, College of Science and Technology, Ota, Nigeria. His present areas of research are in Next Generation Converged-IP Network, Artificial Neural Networks for Signal Processing, Cloud Computing and Broadband Wireless/Wired Technologies (OFDM, MIMO, WiMAX, WiFi, 3G/4G, FTTx). He has technical publications in both national and international journals and several conference proceedings. He is a member of the following professional societies: Council for the Regulation of Engineering in Nigeria (COREN), Nigerian Society of Engineers (NSE), MIEEE and Nigerian Institute of Management (NIM). Dr Frank Ayo Ibikunle is happily and fruitfully married.

Olowononi Felix

Olowononi Felix is currently pursuing his Masters degree in ICT at Covenant University, Ota, Nigeria. His areas of interest are Broadband Wireless Communicatins, LTE and Networking.